

Article number: 20192B20B20402SW

Description: E+G

T-angle clamps GN192-B20-B20-40-2-SW

Measures

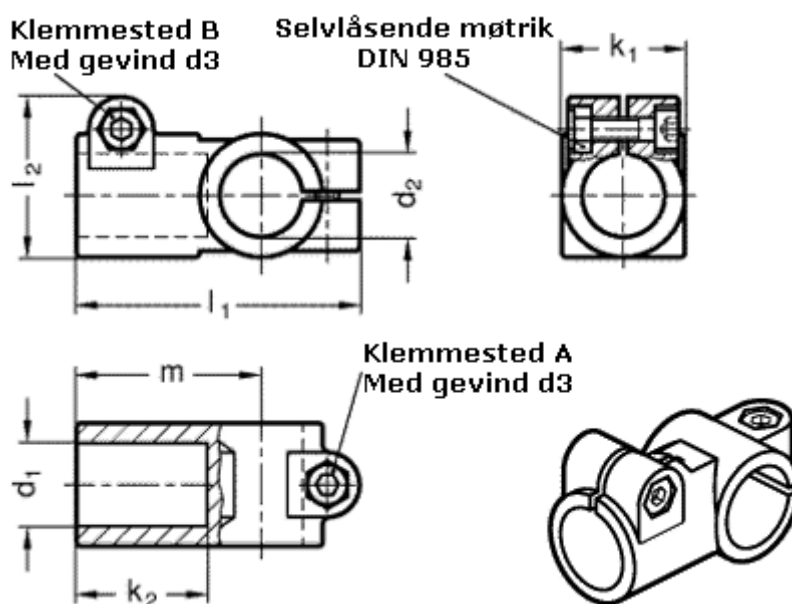

$d_1 = B20$

$d_2 = B20$

$d_3 = M 8$

$k_1 = 40$

$k_2 = 42.5$

$l_1 = 92$

$l_2 = 52.0$

$m = 60$